

# MATISSE 110



dunia®  
COOL TECH



## MATISSE 110

Destaca-se pela sua durabilidade e fiabilidade. Uma gama distintamente marcada pela sua elevada capacidade de carga e apresentação cuidada. Os vidros expositivos com diferentes soluções e plataformas que permitem três níveis de exposição transmitem leveza, simplicidade e versatilidade a este produto. Uma gama muito completa com soluções refrigeradas, aquecidas, neutras e elementos caixa com várias funcionalidades, permitindo a possibilidade de encontrar os melhores recursos para distribuição alimentar e catering.

It stands out for its durability and reliability. A range distinguished by its high load capacity and careful presentation. Display glass with different solutions and platforms that allow three levels of exposure convey lightness, simplicity and versatility to this product. A very complete range with refrigerated, heated, neutral solutions and support counter elements with various functionalities, allowing the possibility of finding the best resources for food distribution and catering.

Elle se démarque par sa durabilité et sa fiabilité. Une gamme qui se distingue par sa capacité de charge élevée et sa présentation soignée. Les vitres d'exposition avec différentes solutions et plates-formes qui permettent trois niveaux d'exposition confèrent légèreté, simplicité et polyvalence à ce produit. Une gamme très complète avec des solutions réfrigérées, chauffées, neutres et des éléments caisses aux fonctionnalités variées, permettant de trouver les meilleures ressources pour la distribution alimentaire et la restauration.



**FUNCIONALIDADE  
ESTÉTICA**

FUNCTIONALITY  
AESTHETICS

FONCTIONNALITÉ  
ESTHÉTIQUE



**QUALIDADE**  
QUALITY / QUALITÉ

## Exposição positiva

POSITIVE EXPOSITION / EXPOSITION POSITIVE

0 / +5 °C

Disponível nas versões ventilada (V), saladas (S), peixe (PX)

| Available in ventilated, salads, seafood versions

| Disponible en versions ventilée, salades, poisson

## Exposição aquecida

HEATED EXPOSITION / EXPOSITION CHAUFFÉE

+65 / +90 °C

Disponível nas versões tampo aquecido (TA), aquecida ventilada (AV) e banho-maria (BM)

| Available in hot plate versions, ventilated dry heat and bain-marie

| Disponible en versions plaque chaude, chauffé ventilée et bain-marie

## Exposição ambiente

AMBIENT EXPOSITION / EXPOSITION AMBIANTE

- °C

Disponível nas versões neutra (N), pão (P), caixa 1 nível (CX1N), distribuidor (DT)

| Available in neutral, bread, 1-level support counter, dispenser

| Disponible en versions neutre, pain, caisse à 1 niveau, distributeur

## MÓDULOS / MODULES / MODULES

REFRIGERADAS Refrigerated . Réfrigérée		LINEAR linear . linéaire <sup>2</sup>										ANGULAR Angular . Angulaire			
		937	1025	1250	1350	1562	1675	1875	2187	2500	3125	3750	AEC	AIC	AEQ
<b>VENTILADA<sup>1</sup></b> Ventilated Ventilée	V	●	-	●	-	●	-	●	●	●	●	22.5° 45°	22.5°	90°	90°
<b>SALADAS</b> Salads Salades	S	-	●	-	●	-	●	-	-	-	-	-	-	-	-
<b>PEIXE</b> Seafood Poisson	PX	-	-	●	-	●	-	●	-	-	-	-	-	-	-

T. Amb. = 25 °C; H.R. = 60%

AQUECIDAS Heated . Chauffé		LINEAR linear . linéaire <sup>2</sup>					
		937	1025	1250	1350	1562	1675
<b>AQUECIDA VENTILADA<sup>1</sup></b> Ventilated dry heated Chauffé ventilée	AV	●	-	●	-	●	-
<b>TAMPO AQUECIDO</b> Heated deck Plaque chaude	TA	-	●	-	●	-	●
<b>BANHO-MARIA</b> Bain-marie Bain-marie	BM	-	●	-	●	-	●

NEUTRAS Neutral . Neutre		LINEAR linear . linéaire <sup>2</sup>								ANGULAR Angular . Angulaire			
		937	1250	1562	1875	2187	2500	3125	3750	AEC	AIC	AEQ	AIQ
<b>NEUTRA</b> Neutral Neutre	N	●	●	●	●	●	●	●	22.5° 45°	22.5°	90°	90°	
<b>PÃO<sup>1</sup></b> Bread Pain	P	●	●	●	●	●	●	●	-	-	-	-	

NEUTRAS Neutral . Neutre		LINEAR linear . linéaire <sup>2</sup>		ANGULAR Angular . Angulaire	
		600	1000	AER	AIR
<b>CAIXA 1 NÍVEL</b> 1 level sup. counter Caisse 1 niveaux	CX1N	●	●	45° 90°	45° 90°
<b>DISTRIBUIDOR<sup>4</sup></b> Dispenser Distributeur	DT	●	●	-	-

<sup>1</sup>Versão vitrina e semi-mural | Display case and semi-vertical version | Version vitrine et semi-verticale

<sup>2</sup>Comprimento sem laterais | Length without side panels | Longueur sans joues

<sup>3</sup>Versão semi-mural | Display semi-vertical version | Version semi-verticale

<sup>4</sup>Distribuidor de pão, talheres, copos e tabuleiros / Bread, cutlery, glasses and trays dispenser / Distributeur de pain, couverts, verres et plateaux

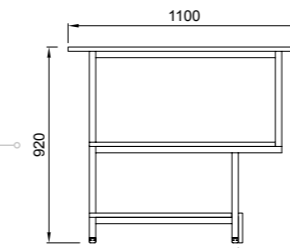
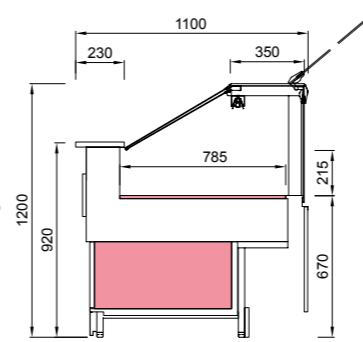
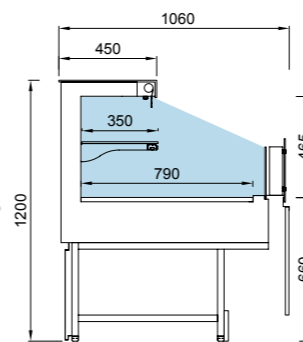
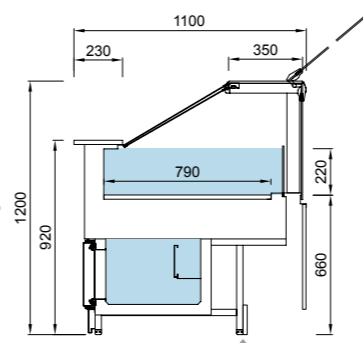

## VIDRO EXPOSITIVO EXPOSITIVE GLASS / VITRAGE EXPOSITIF

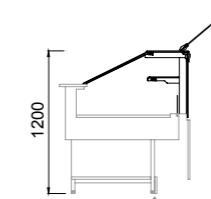

VPB

VPB - Vidro plano baixo  
Low flat glass  
Vitrage droit bas

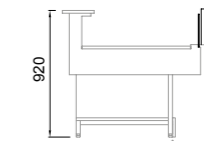

VS VIT

VS - Vidro self-service  
Self-service glass  
Vitrage self-service

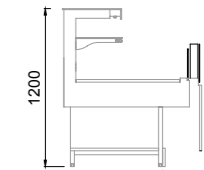

VS SM

## ÂNGULOS CORNERS / ANGLES

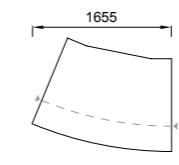

AEC22.5

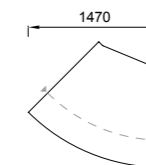

AEC45

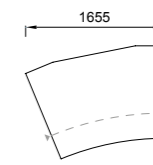

AIC22.5

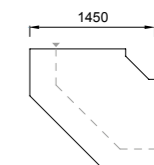

AEQ90

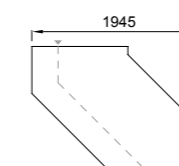

AEQ90L

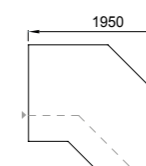

AIQ90

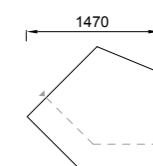

AER45

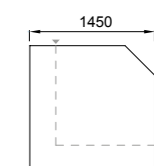

AER90

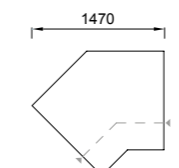

AIR45

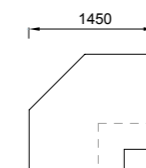

AIR90

AE - ângulo externo  
external corner / angle externe

AI - ângulo interno  
internal corner / angle interne

R - reto  
straight / droit

Q - quebrado  
broken / cassé

C - circular  
circular / circulaire

L - longo  
long / long

Ex: AEQ90 L - ângulo externo quebrado 90° longo / longo broken 90° external angle / angle extérieur long caissé de 90°



[www.dunia.pt](http://www.dunia.pt)

#### AVISO LEGAL / DISCLAIMER / AVERTISSEMENT

AGRADECEMOS A SUA PREFERÊNCIA.

A DUNIA reserva-se no direito de proceder a qualquer actualização sem prévia notificação. Os dados fornecidos são indicativos. A técnica de impressão pode implicar alteração nas cores reproduzidas. A informação apresentada está sujeita a alterações após publicação, certifique-se da validade da brochura.

THANK YOU FOR YOUR PREFERENCE.

DUNIA reserves the right to carry out any updating without prior notification. The data provided is indicative. The printing technique may imply a change in the colors reproduced. The information presented is subject to change after publication, please check the validity of the brochure.

MERCI POUR VOTRE PRÉFÉRENCE.

DUNIA se réserve le droit d'effectuer toute mise à jour sans notification préalable. Les données fournies sont indicatives. La technique d'impression peut impliquer une modification des couleurs reproduites. Les informations présentées sont susceptibles d'être modifiées après publication. Veuillez vérifier la validité de la brochure.

#### MORADA / ADDRESS / ADRESSE

Rua 1º de Maio · Parque industrial de Celeirós  
Pavilhão 37 · 4705-470 Celeirós · Braga  
Portugal

#### CONTACTOS / CONTACTS / CONTACTS

T +351 253 603 040  
[geral@unia.pt](mailto:geral@unia.pt)  
[www.dunia.pt](http://www.dunia.pt)



CAT\_00.1124